



Modular Masonry Fireplaces
Wood-Fired Ovens
Barbecue Smokers
Fire Pits
Kitchen Islands

 **Stone Age**
Manufacturing®
 Modular Masonry Technology at its Finest

Deep Draw
 PRODUCTS
 Manufacturer's Licensee
 and Master Distributor
 for Southeastern United States



Stone Age Manufacturing produces the largest and most complete line of modular masonry kits in the industry.

Stone Age kits simplify construction, saving time on the job.

Designed for easy assembly, our masonry kits help you create custom fireplaces and complete outdoor living areas, in a fraction of the time required for traditional construction. Less time on the project means lower labor cost.

Stone Age products are built strong, adding value to your home.

Stone Age fireplaces and wood-fired ovens are made with reinforced, heat-tolerant concrete, for outstanding strength and durability, with designs that are engineered to deliver superior performance. Our patented Cabinet Component System™ outdoor kitchen islands offer simple and strong solutions that are compatible with any brand of appliances.

Stone Age kits easily transform your outdoor living dreams into reality.

Stone Age kits are easily customized to fit any design or layout, without compromising their performance or structural integrity. Our products are designed to seamlessly work together, offering a complete fireplace and outdoor living system that is compatible with any masonry finish material, to easily complement any home design or outdoor room setting.

Stone Age fireplaces simply work better.

Stone Age fireplaces are designed differently than other masonry fireplace kits, and these differences are readily apparent when you compare them side by side. Our fireplaces are made to draft strongly in conditions that have other brands spilling smoke into the seating and viewing area.

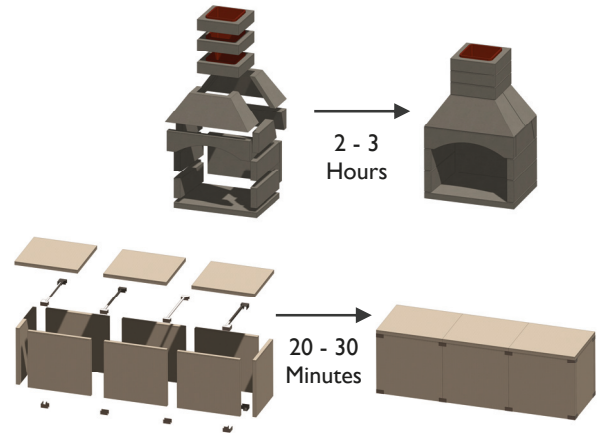

Stone Age vs. Other Brands



NEW AGE™ ZERO-CLEARANCE FIREPLACES



New Age™ fireplaces offer our widest range of sizes, in a form factor optimized for zero-clearance applications, or any project where a square profile is preferred.

New Age™ fireplaces are tested to UL-127/ULC-S610 and UL-103, and are certified as zero-clearance fireplaces, allowing framing directly against the kit. New Age™ fireplaces have also been tested to ICC-ES AC156 for tolerance to seismic activity.

- Indoor or Outdoor Applications • Wood or Gas Fuel
- Arched or Straight Lintel



Arched Lintel



NEW AGE™ ZERO-CLEARANCE FIREPLACES



Straight Lintel

36"

42"

48"

60"

72"

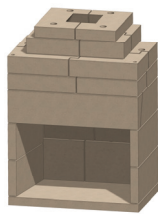

Front View

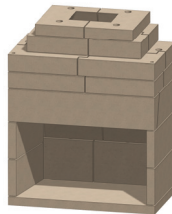

Front View

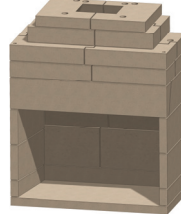

Front View

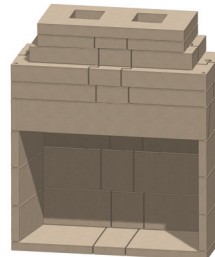

Front View

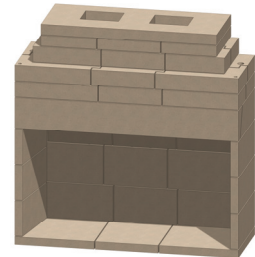

Front View

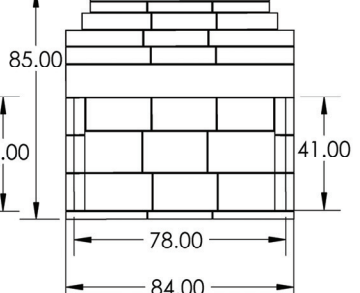
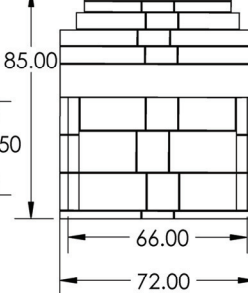
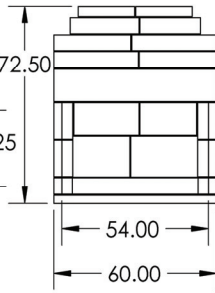
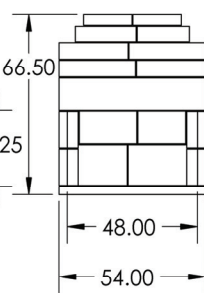
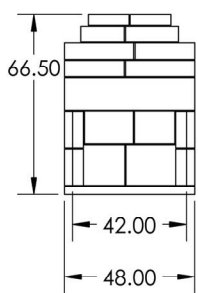

Arched Lintel

36"

42"

48"



Front View

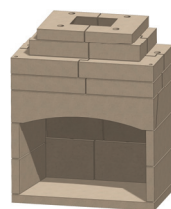

Front View



Front View

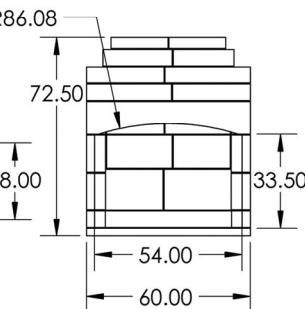
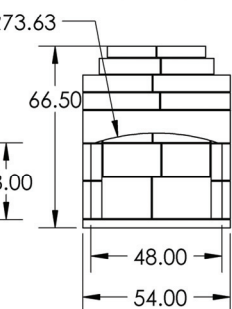
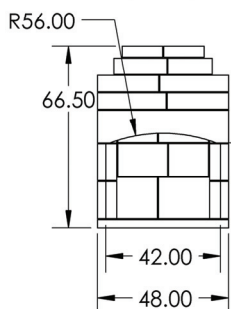

Depth
All Models

Side View

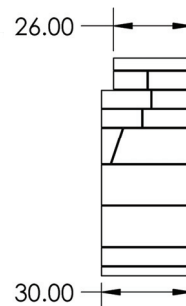

Options

Masonry or Metal Chimney

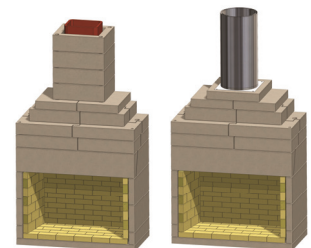

Wood Storage

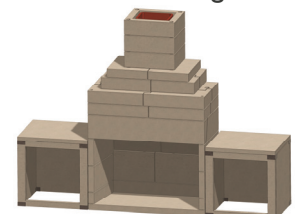

STANDARD SERIES FIREPLACES



Standard Series fireplaces are the flagship model of the Stone Age line, and are complete kits, with everything needed to construct the fireplace included, except mortar and finishing materials.

Standard Series fireplaces are tested to UL-127/ULC-S610.

Includes Riser Legs, Hearth, Firebrick & 4 Chimney Sections

- Indoor or Outdoor Applications
- Wood or Gas Fuel
- Arched or Straight Lintel



24"

36"

48"

Options

See-Thru Models

Straight Lintel

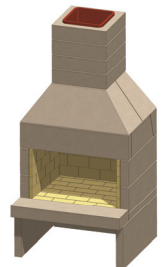
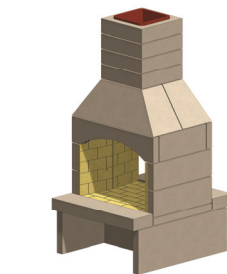

Wood Storage

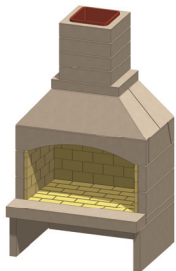
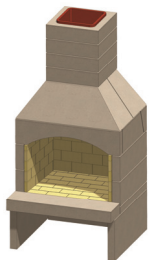
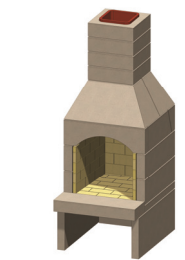
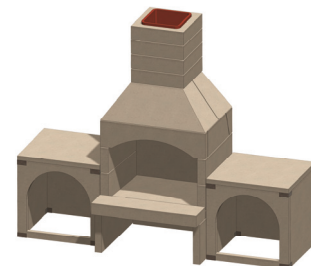

Depth
All Models

Side View

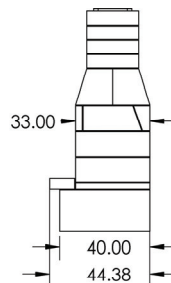
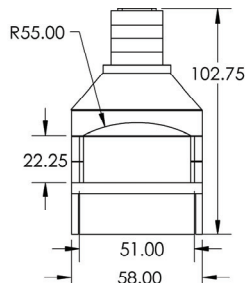
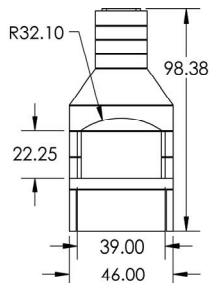
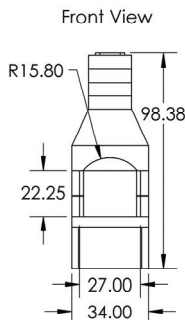

CONTRACTOR SERIES FIREPLACES



Contractor Series fireplaces offer Stone Age design and quality with an emphasis on value, and are the perfect choice for applications where a custom hearth or unique profile is desired.

Contractor Series fireplaces are tested to UL-127/ULC-S610.

Includes Firebox, Tapered Throat & 3 Chimney Sections

- Indoor or Outdoor Applications • Wood or Gas Fuel
- Arched or Straight Lintel



24"

36"

48"

Options

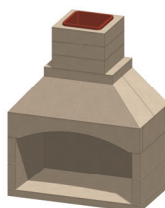
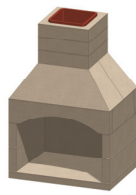

Straight Lintel

See-Thru Models

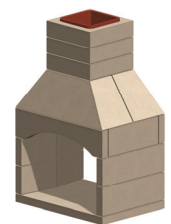

Depth
All Models

Front View

Front View

Front View

Side View

Wood Storage

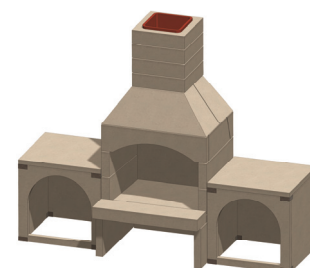
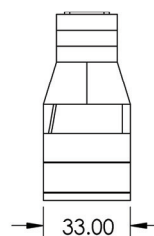
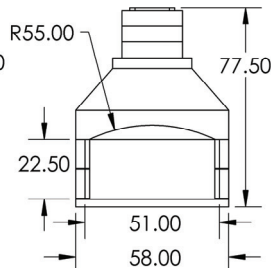
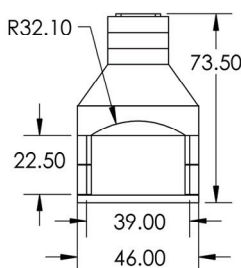
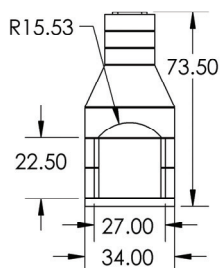

WOOD-FIRED OVENS & SMOKERS



Stone Age wood-fired ovens and barbecue smokers feature superior designs and the highest quality materials available, for outstanding value and performance.

- Oven Cooking Temperatures up to 800°F • Low Temperature Smoking
- Seamless Integration with Cabinet Component System™ Islands

Amerigo™

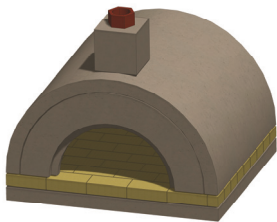

Front View

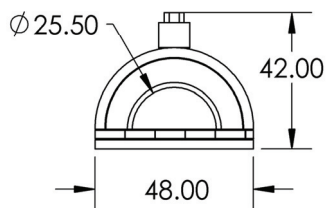

Cooking Surface: 1500 sq. in.

Mezzo™

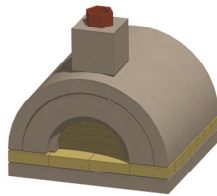

Front View

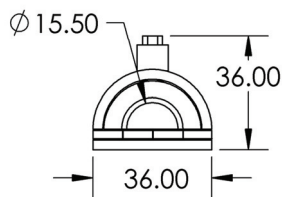

Cooking Surface: 800 sq. in.

Little Pig™ Smokehouse

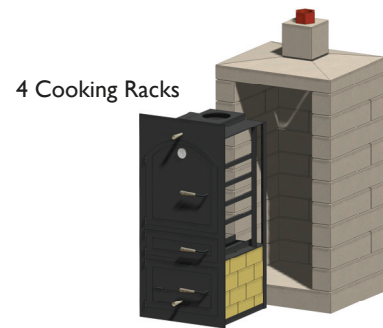

4 Cooking Racks

Front View

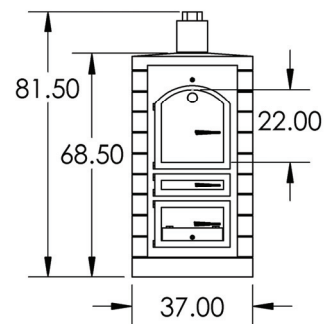

Options

Wood Storage



Amerigo™

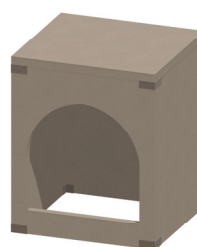
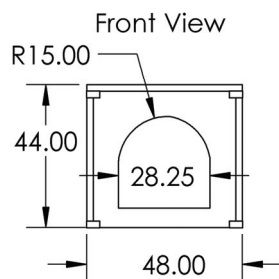

Mezzo™

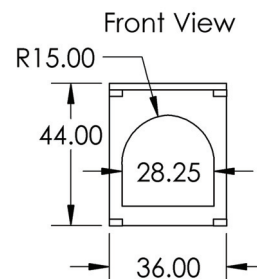

COMBO FIREPLACE OVENS



Caminetto Grande™

Caminetto™ models combine a 63” or 75” wood burning fireplace with a wood-fired oven.

Enjoy delicious pizza and other dishes, the ambiance of a wood fire, and the convenience and beauty of two appliances in a single package.

Caminetto™ Medeo

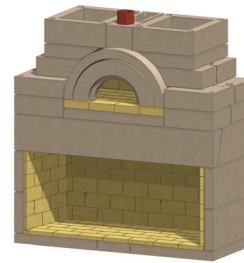

Caminetto™ Grande

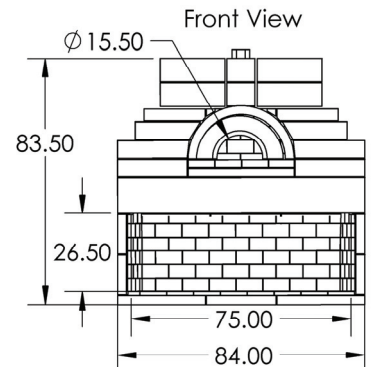
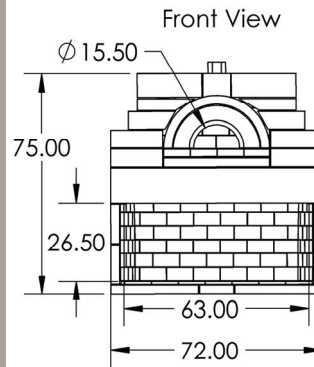
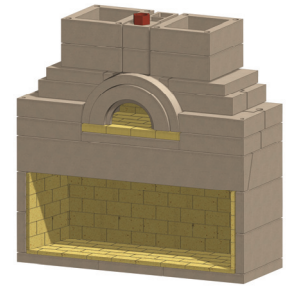

Depth (Both Models): 30”



Stone Age Multi-Purpose Ready-Mix is a comprehensive blend of refractory mortar and other additives, specifically formulated for the construction and finishing of all Stone Age products.

Designed to withstand the high temperature conditions encountered by wood burning hearth products, Stone Age Multi-Purpose Ready-Mix provides superior performance in fireplace, fire pit or oven joints, as well as firebrick installation.

- **Superior Heat Tolerance**
- **High Adhesion for Finish Materials**
- **Extended Working Time**
- **Smooth Texture for Easy Application**
- **Low Moisture Absorption**
- **High Strength**

FIRE PITS

Stone Age Fire Pits add campfire-style warmth and enjoyment to any outdoor setting.

The same steel reinforced, heat-tolerant concrete blend used in our fireplaces gives them outstanding durability.

- Wood or Gas Fuel

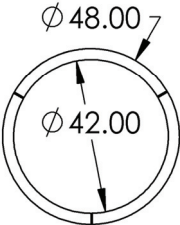

Height: 18"



Large Round

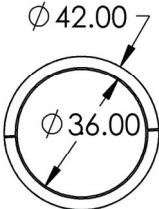
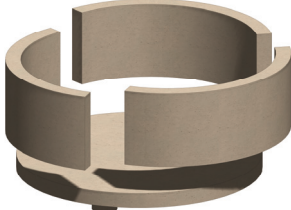

Height: 25"



Tall Round

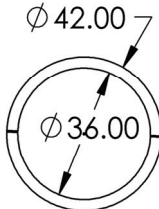
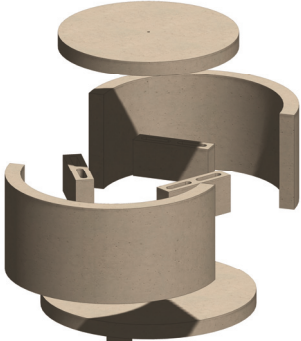

Height: 14"



Short Round

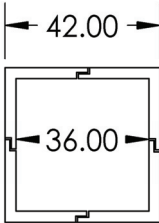
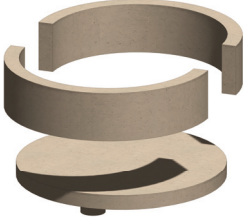

Height: 15"



Square

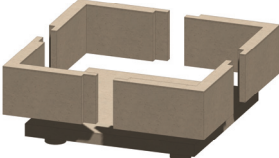

CABINET COMPONENT SYSTEM™ ISLANDS



Cabinet Component System™ outdoor kitchen islands deliver unmatched quality, strength, and durability, with unparalleled design flexibility for outdoor kitchens and entertainment areas.

Our patented lightweight, glass fiber reinforced concrete panel and galvanized steel bracket system creates infinitely configurable kitchen island layouts that assemble in minutes, yet deliver strength and durability far superior to other systems. Kits are available in 3' increments, and are easily modified to any length.

Panels

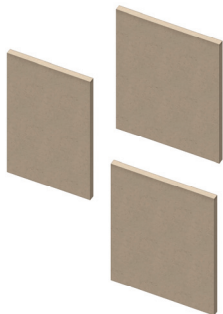

Brackets

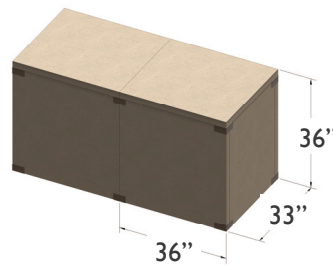

Common Dimensions - All Kits

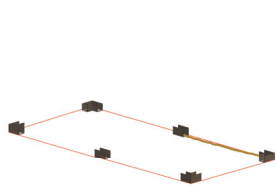

1. Create chalk outline and use landscape block adhesive to secure 1st panel & brackets.

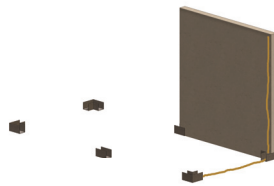

2. Begin at a corner, securing to the pad, and set the beads of adhesive for the adjoining end panel.

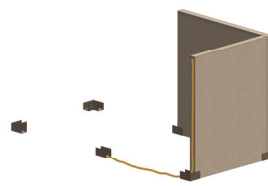

3. Add 1st end panel, securing to wall panel and adding adhesive beads for the bottom and end joints.



4. Add next wall panel and upper bracket.

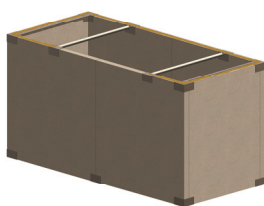

5. Continue placing panels and brackets to complete wall assembly.

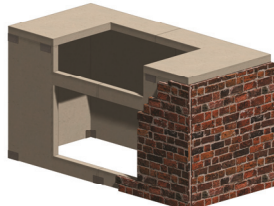

6. Make cut-outs and apply finish to unit before installing appliances.

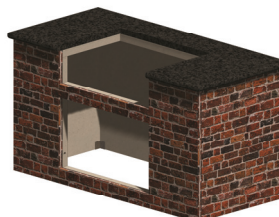

7. Drill anchor pilot holes into panels for doors and appliances.



8. Installation Complete.

- 27 Standard Kit Configurations
- Combine Kits to Create Unique Island Layouts
- Customize to Build Any Design You Can Imagine

STR Series

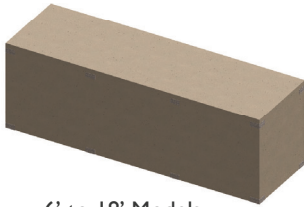

6' to 18' Models

L Series

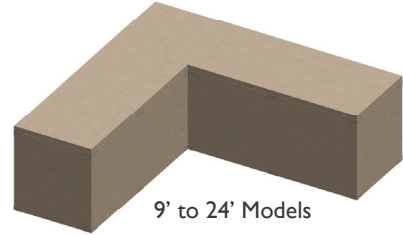

9' to 24' Models

F Series

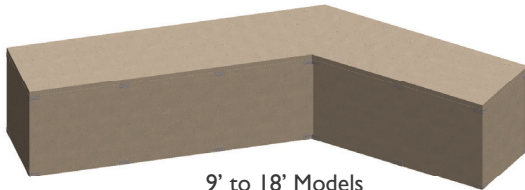

9' to 18' Models

FF Series

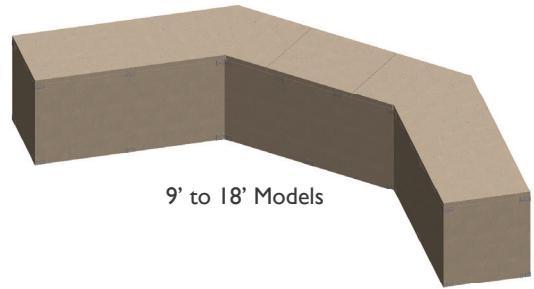

9' to 18' Models

U Series

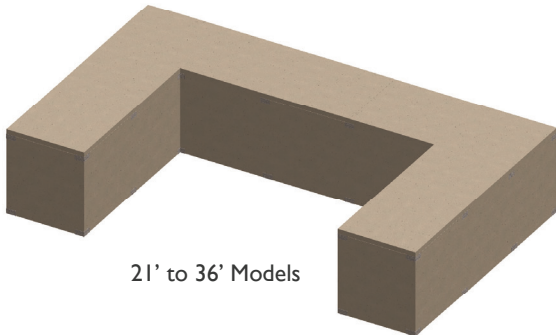

21' to 36' Models

Radiused Series

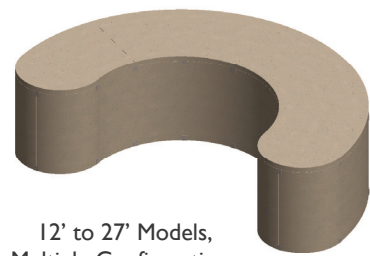

12' to 27' Models,
Multiple Configurations

Options

Backsplash

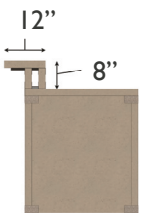

Bar Top

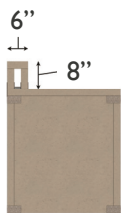

Standard

Straight Island Kits



Radiused Island Kits



Radiused End Cap



Radiused Island Sections

Ceramic Cooker Cabinet

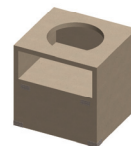



For immediate access to more detailed product information, please use this QR code, or visit our website at: <https://stoneagemanufacturing.com>.



To access our complete Product Ordering Guide, please use this QR code, or visit our website and download it at: <https://stoneagemanufacturing.com/technical-documents/>.



Deep Draw

PRODUCTS

83 Deep Draw Lane
Crossville, TN 38555

931-267-1545

<https://deepdrawproducts.com>

deepdrawproducts@gmail.com

Manufacturer's Licensee and Master Distributor
for Southeastern United States

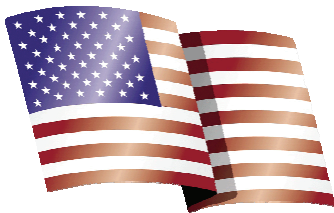

Proudly Made In USA



Modular Masonry Technology at its Finest

Web: <https://stoneagemanufacturing.com>

Email: info@stoneagemanufacturing.com

US Toll Free: (877) 371-8861

Phone: (918) 371-8861

Fax: (918) 371-8850

Tested &
Listed by



Portland
Oregon USA

OMNI-Test Laboratories, Inc.



www.facebook.com/StoneAgeMfg



www.youtube.com/user/StoneAgeMFG



www.instagram.com/stoneagemfg



www.pinterest.com/stoneagemfg



www.houzz.com/pro/stoneagemfg

Rev 1019

Stone Age Manufacturing, Inc.

©2019, All Rights Reserved